

# Lowe's backdrop building kit in HO scale

Parking lot base, lawn mowers and cars not included

This kit includes all building parts and signs milled in white styrene plastic and clear window glazing. Plastruct corrugated metal roofing. All parts fit together but may need light sanding in joints for cosmetic reasons. The model needs painting.

Some model building and painting skills are required. Size: 23 1/2" x 3 3/4" x 5 1/2" (600 x 95 x 140 mm)



Manufactured by Custom Cuts by 

Summit USA LLC, 512 Ford Street, Lake Charles, LA 70601  
[www.summit-customcuts.com](http://www.summit-customcuts.com)

## Assembly instructions for Lowe's backdrop building

Thank you for buying this Lowe's backdrop building. Please take some time to read these instructions before you begin assembling.

This kit is milled in styrene plastic and is very easy to glue together using Plastruct Plastic Weld or similar glue products. The wall parts are tabbed and slotted for easier assembly. Take your time to identify all parts, lay them out and clean them for any burrs before gluing them together.

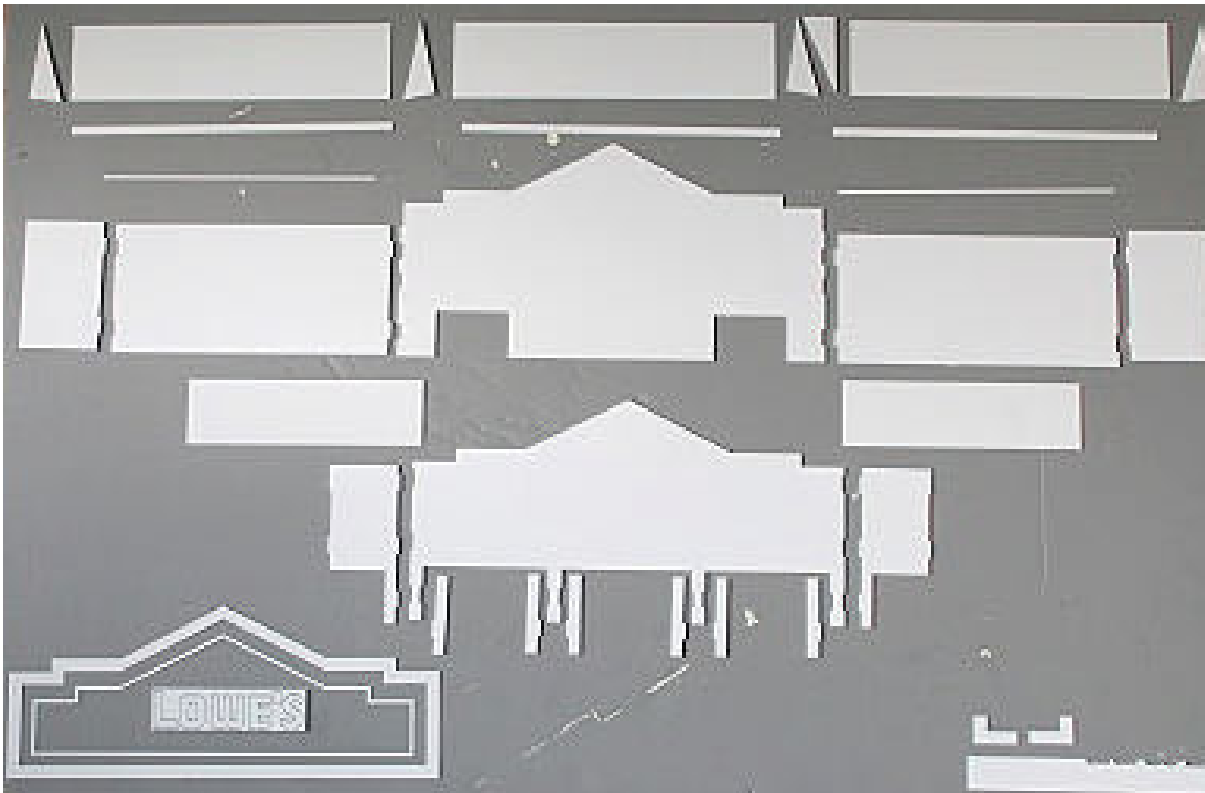

Parts overview

Positioning tools

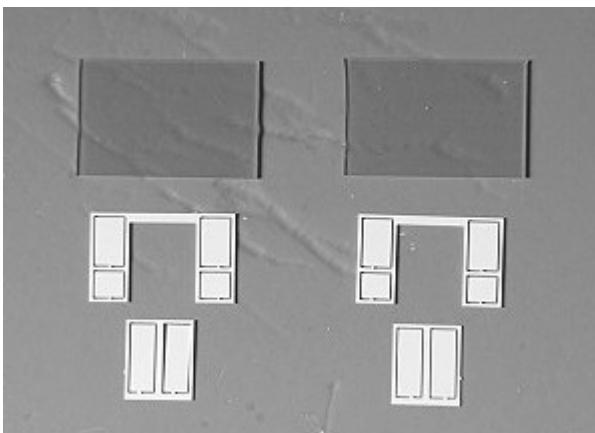

Doors and glass

Start by attaching the sides to the front wall, then mount all the column sides to the column fronts, fitting the tabs and slots.

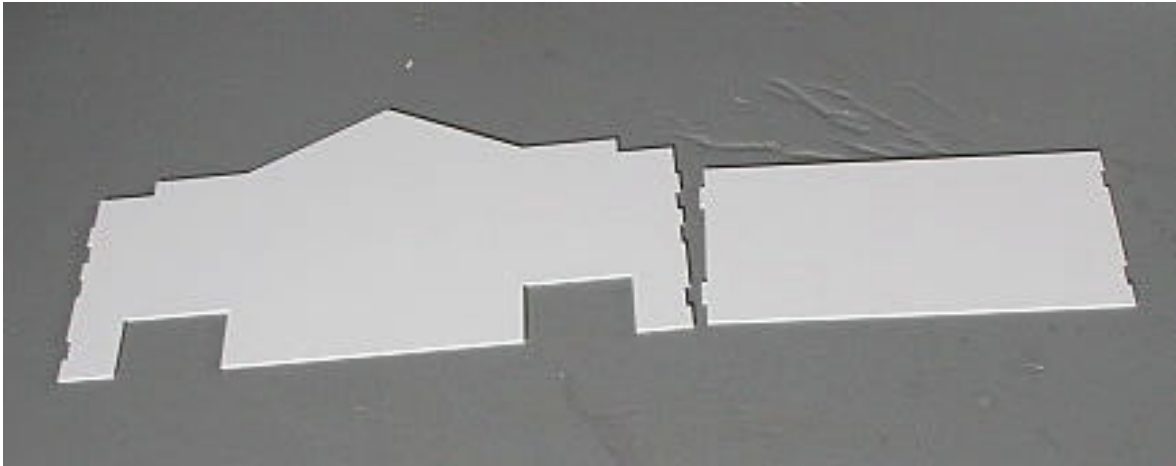
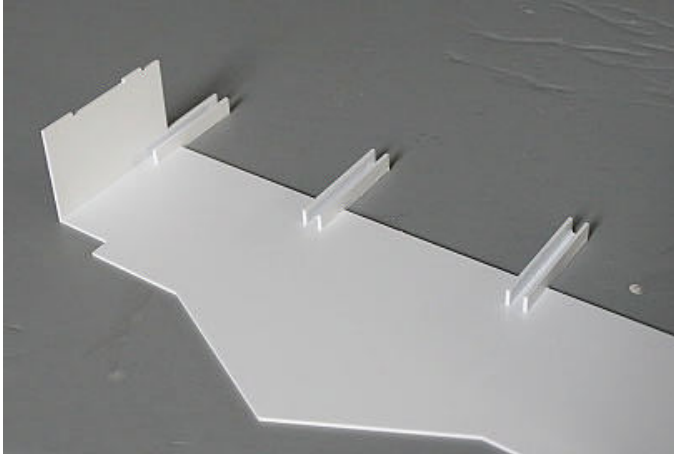
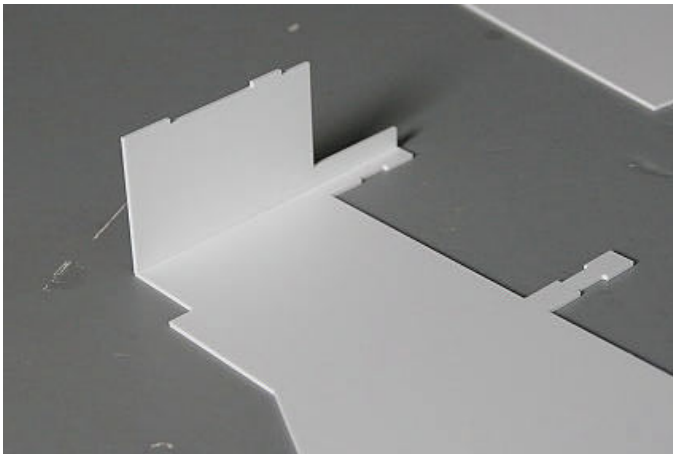

Glue the right and left fronts to the centerpiece as shown

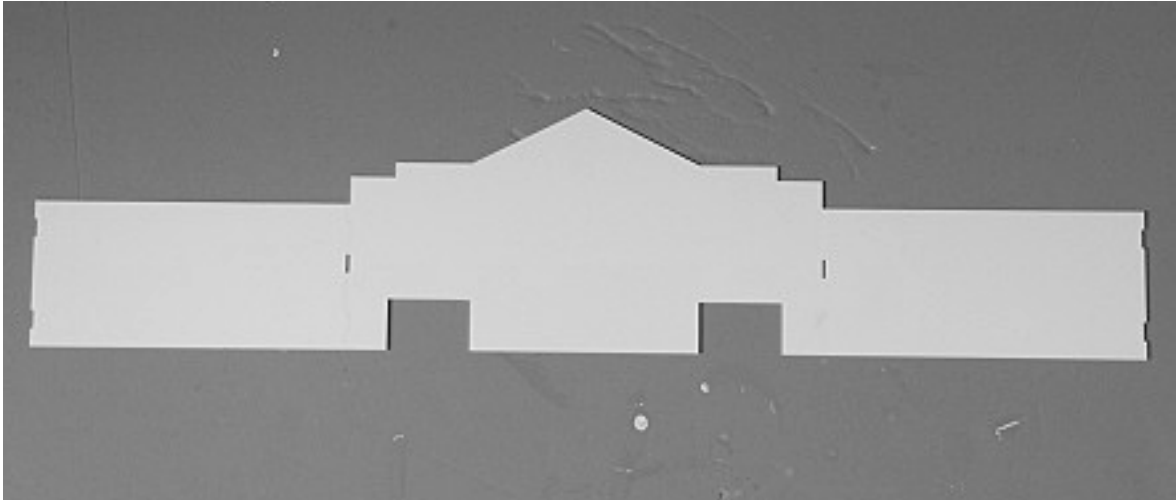

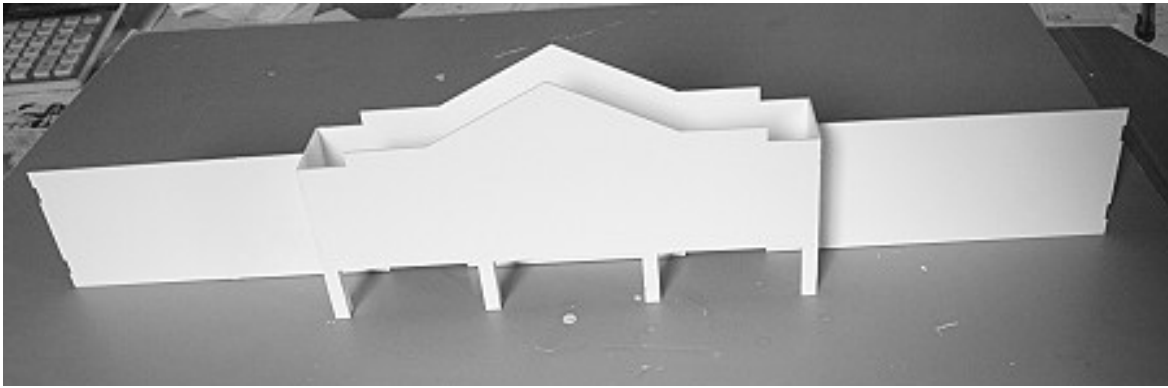

Sand the joints and fill with Model Filler if necessary. Before you glue in the plain styrene roof pieces, use them as a template to cut the corrugated roof sheet to size. Glue the plain styrene roof pieces on as a sub-roof, approx. 1/4" (6mm) below the edge of the wall.

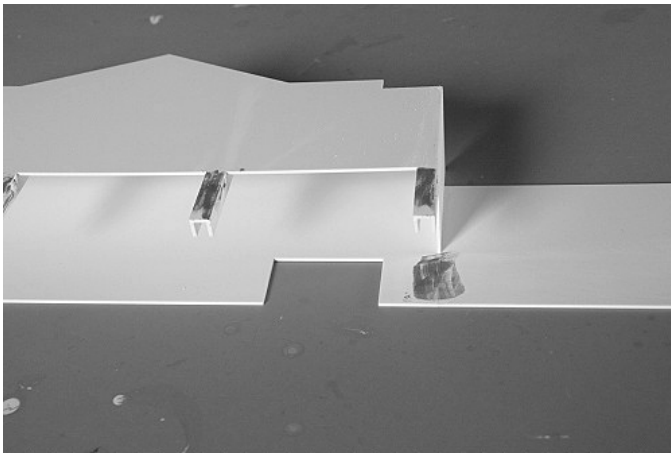

When the Model Filler has dried, sand the joints with 120 grit sandpaper until the surface is even, then sand with 600 grit sandpaper to get a nice smooth surface.

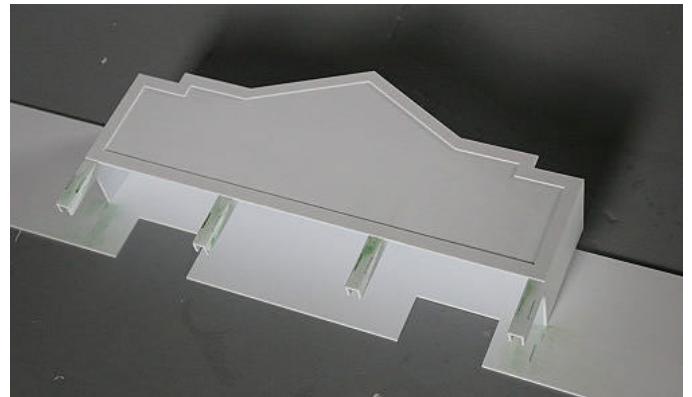
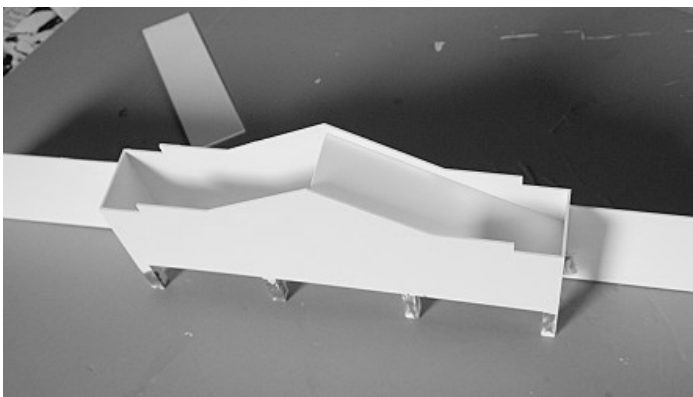

Glue on the outer trim piece around the front wall as shown in the picture above.



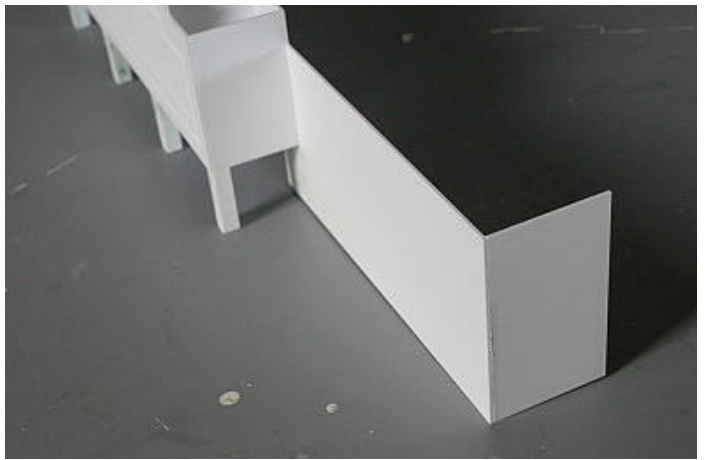
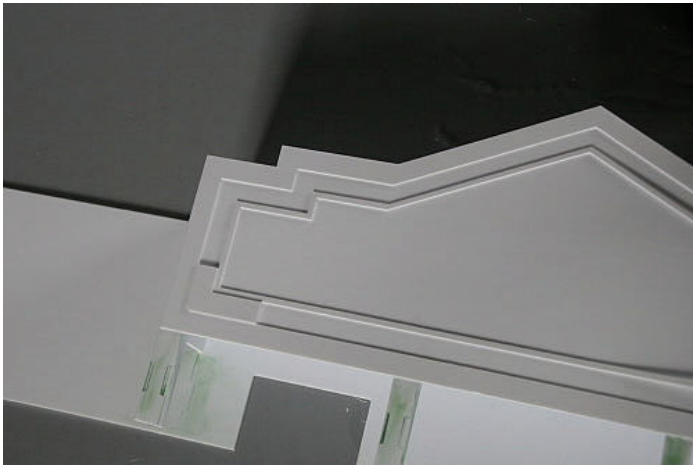

Place the 2 L-shaped guide pieces inside the trim's lower corners as shown above and install the narrow trim piece. Glue on the short sidewalls, aligning the tabs and slots.

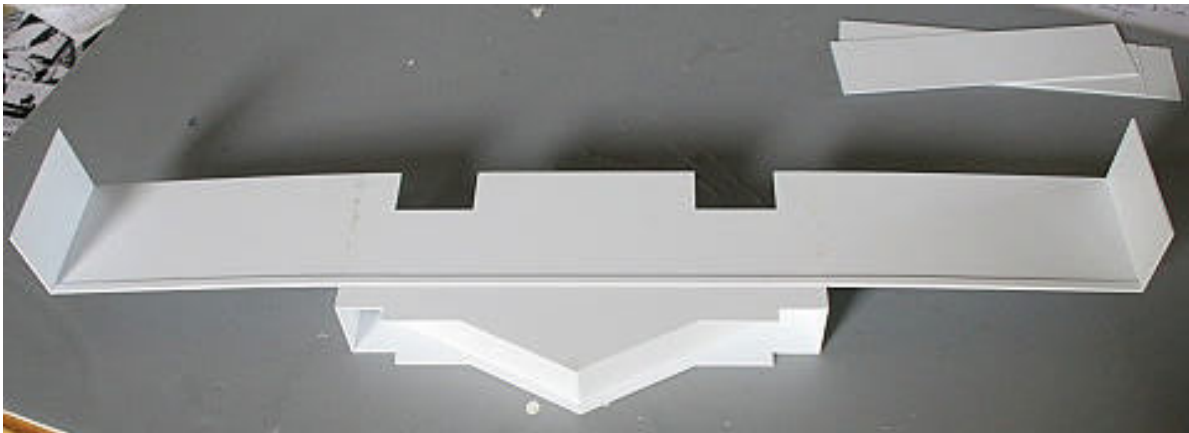

On top of the rear side of the front wall, glue on the three 1/4" strips, aligning with the top edge.

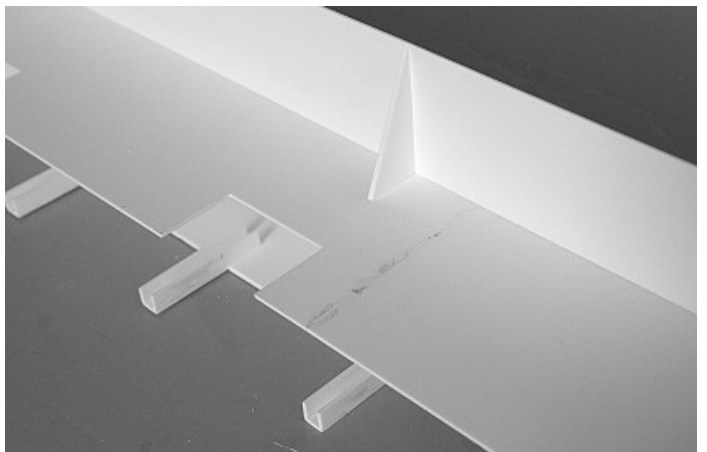
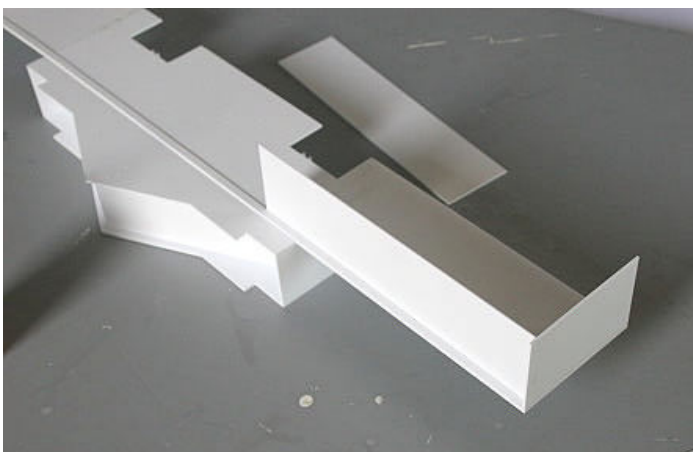

Glue the three roof pieces under the strip and glue the triangles under the joints for support. Spread the 3 remaining triangles evenly along the roofline. See next page.

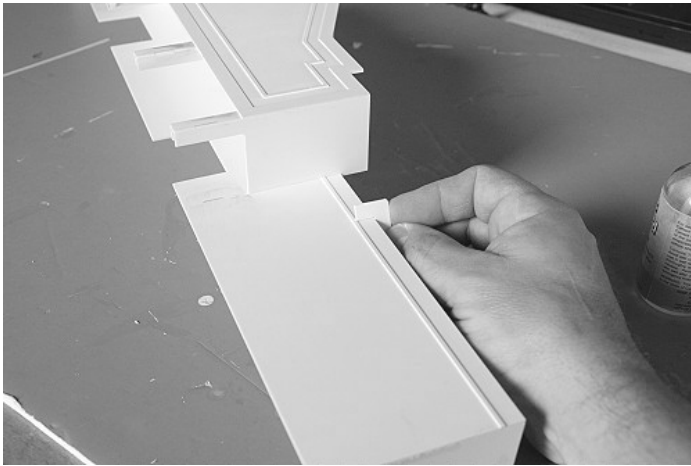
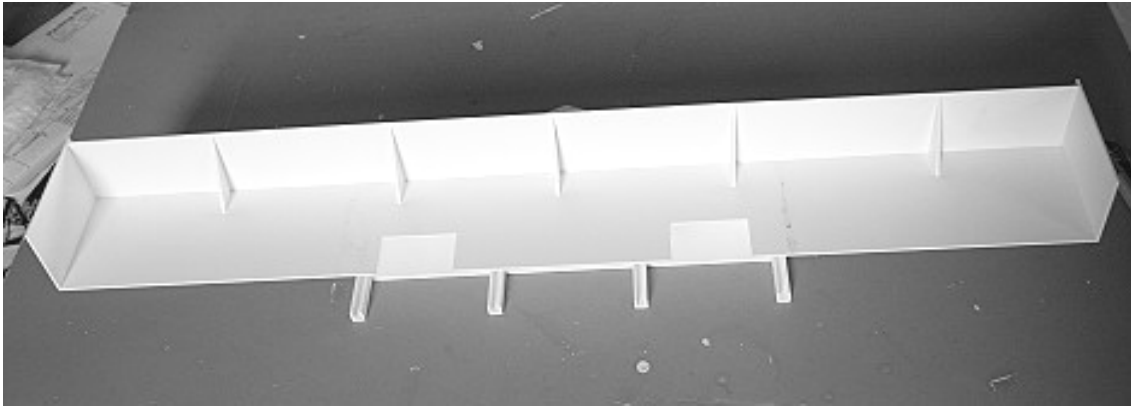

Use the L-shaped guide to position the trim strip on the upper walls.

## Painting

Begin by mounting the logo letters on a piece of cardboard with double-sided tape. On another piece of cardboard, mount the doors and door frames. Then spray the entire model with gray primer, Floquil makes a 3 oz. spray can. Next, paint the light gray parts - the upper walls, the columns and the 2<sup>nd</sup> trim frame on the front.

When the paint has dried (the next day), mask off the light gray areas and paint the dark gray. Paint the logo letters white. If you don't paint them, the bare styrene will turn yellow over time.

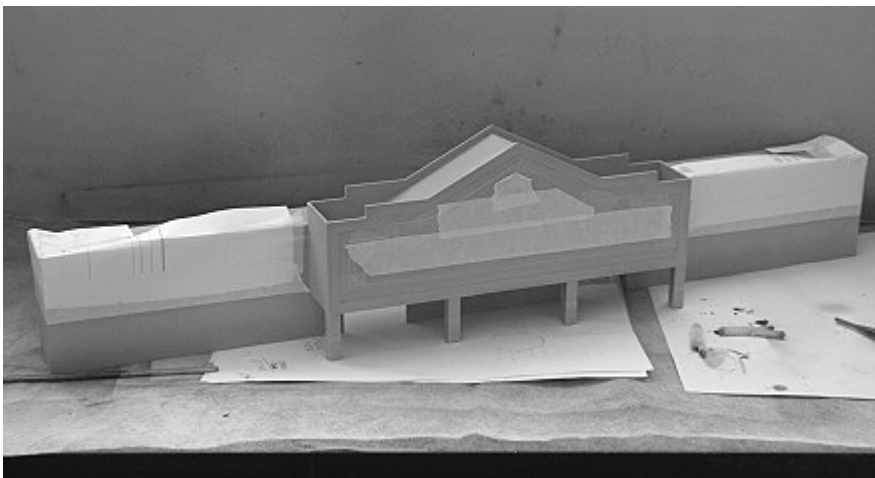

When the dark gray has dried, mask off the entire building except the thin frame on the front and the trim strips on the walls and paint them red.

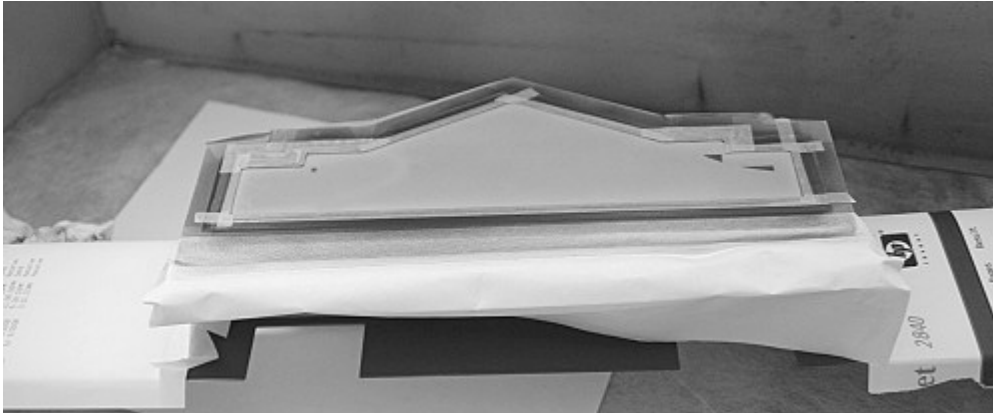

When the red has dried, mask it off and paint the dark blue. Also paint the 2 corrugated roof parts dark blue.

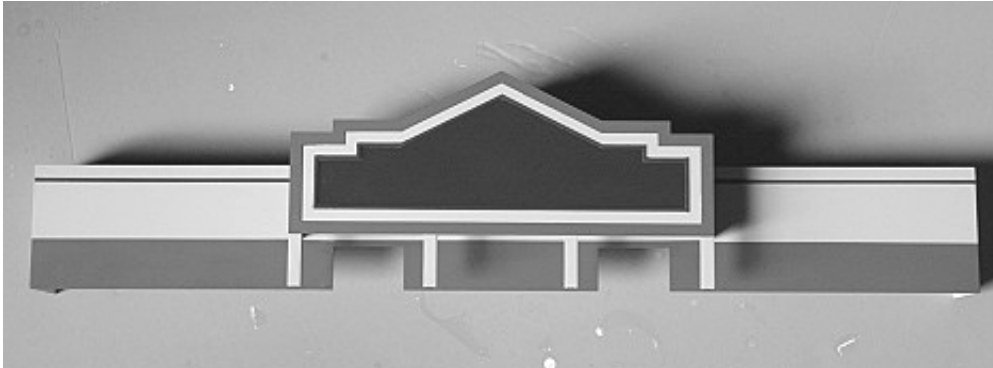

Paint the doors and doorframes silver or aluminum.

## Final assembly

Mount the window glazing from behind. The window glazing is clear. If you want it tinted as on this demonstration model, you can apply some car window film. This you can buy in any auto parts store.

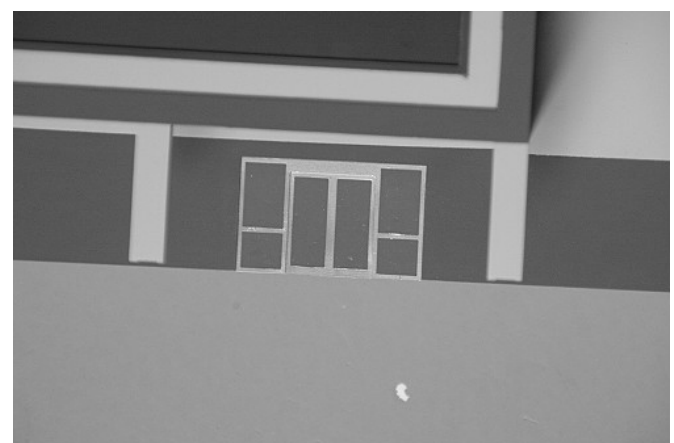
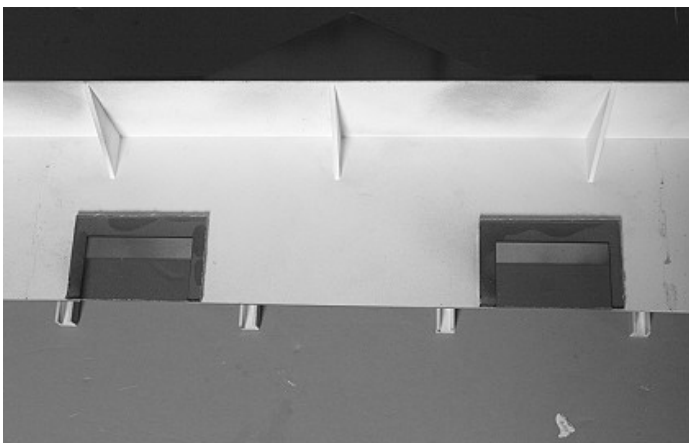

Mount the window frames and doors on the glazing. It is best to glue it with some tiny drops of Crystal Clear or a similar liquid glass product.

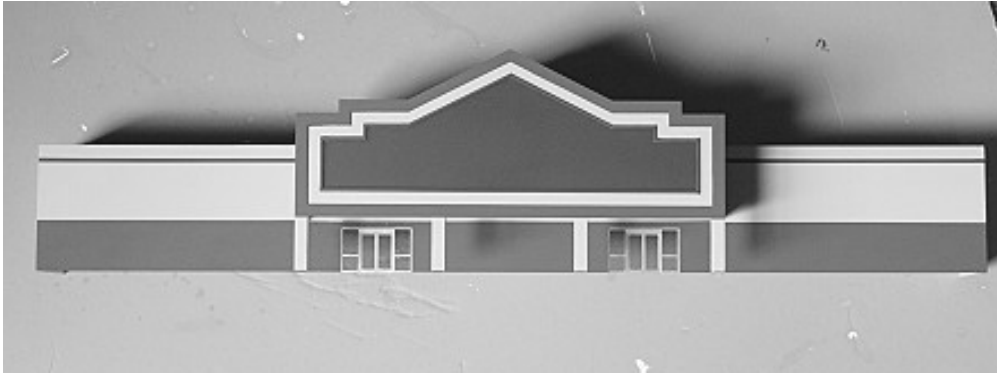

Mount the blue roof parts on the sub-roof. Place the logo positioning tool in the corner as shown below.

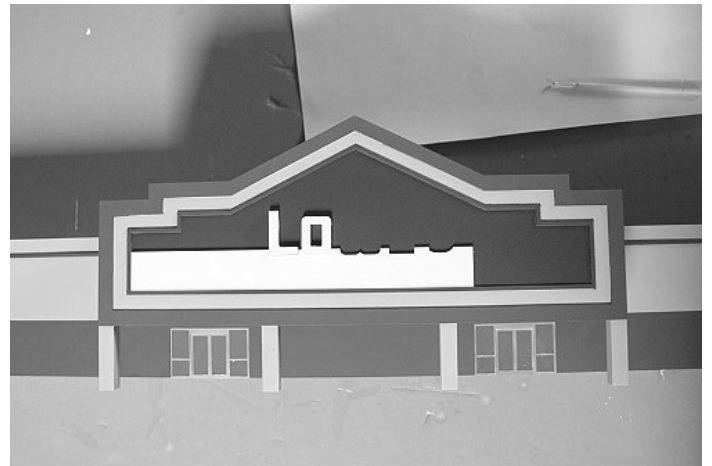
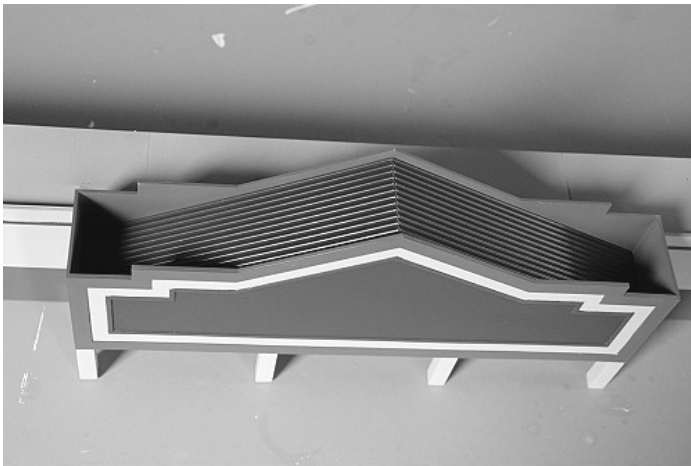

Attach the logo letters with a very thin layer of white glue or Woodland Scenic Accents Glue. When the glue has set, remove the positioning tool.

The colors used on this model are:

Testors #1726 Light sea gray, Testors #1723 Gunship Gray, Testors #1772 Blue Angel Blue, Testors #1781 Aluminum, Floquil #110011 Reefer White, Floquil #110450 SOO Line Red

The lawn mowers shown in the front page picture are from NuComp Miniatures and the ride-on mowers are from Wiking.

Enjoy your Lowe's on your layout.



Here are some other products you may enjoy in a future project:



#SMFS Summit Motel, full version



#DP-001 Domino's Pizza take-out



#CS-001 Dave's Coffee Shop



#TB-001 Taco Bell Restaurant



#CVS-001 CVS Pharmacy



#LO-001 Lowe's backdrop building



Mall complex



#ML-001 Strip Mall backdrop building #1



#ML-002 Strip Mall backdrop building #2



#ML-003 Office Depot backdrop building



#ML-004 Mall street sign



#ML-005 Pier 1 Imports backdrop building



#ML-006 Dollar Tree backdrop building



#EX-001 Exxon Gas Station & Store



#SW-001 Subway Restaurant





#WH-001 Waffle House Restaurant



#SC-001 Rural Shamrock Gas Station & Store



#SH-001 Shell Gas Station & Store



#DG-001 Dollar General Store



#MH-001 Modern Manufactured Home



#GS-001 Arco Gas Station backdrop



#FS-001 Modern City Fire Station



#JL-001 Jiffy Lube

Keep updated for new products on our website: [www.summit-customcuts.com](http://www.summit-customcuts.com)